

AC Filter for PCB Mounting



Shield made of nickel-silver

Shield

See below:
[Approvals and Compliances](#)

Description

- Line filter in standard and medical version

Characteristics

- Ultra-compact design
- Shield available separately (German silver)
- Suitable for use in equipment according to IEC/UL 60950
- Suitable for use in medical equipment according to IEC/UL 60601-1

Weblinks

[pdf data sheet](#), [html datasheet](#), [General Product Information](#), [Distributor-Stock-Check](#), [Detailed request for product](#), [Microsite](#)

Technical Data

Ratings IEC	1 - 10A @ Ta 40 °C / 250 VAC; 50Hz
Ratings UL/CSA	1 - 10A @ Ta 40 °C / 125 VAC; 60Hz
Leakage Current	standard < 0.5 mA (250 V / 60Hz) medical < 5 µA (250 V / 60 Hz)
Dielectric Strength	> 1.7 kVDC between L-N > 2.7 kVDC between L/N-PE Test voltage (2 sec)
Allowable Operation Temperature	-25 °C to 85 °C
Climatic Category	25/085/21 acc. to IEC 60068-1
Protection Class	Suitable for appliances with protection class I acc. to IEC 61140
Terminal	For PCB mounting tin-plated
Material: Housing	Thermoplastic, UL 94V-0

Line Filter	Standard and Medical Version, IEC 60939, UL 1283, CSA C22.2 no. 8 Technical Details
MTBF	> 5'900'000h acc. to MIL-HB-217 F

Approvals and Compliances

Detailed information on product approvals, code requirements, usage instructions and detailed test conditions can be looked up in [Details about Approvals](#)

SCHURTER products are designed for use in industrial environments. They have approvals from independent testing bodies according to national and international standards. Products with specific characteristics and requirements such as required in the automotive sector according to IATF 16949, medical technology according to ISO 13485 or in the aerospace industry can be offered exclusively with customer-specific, individual agreements by SCHURTER.

Approvals









The approval mark is used by the testing authorities to certify compliance with the safety requirements placed on electronic products.

Approval Reference Type: 5500

Approval Logo	Certificates	Certification Body	Description
	VDE Approvals	VDE	Certificate Number: 101307
	UL Approvals	UL	UL File Number: E72928



Product standards

Product standards that are referenced

Organization	Design	Standard	Description
	Designed according to	IEC 60320-1	Appliance couplers for household and similar general purposes
	Designed according to	IEC 60939	Passive filters for suppressing electromagnetic interference
	Designed according to	IEC 60127-6	Miniature fuses. Part 6. Fuse-holders for miniature fuse-links
	Designed according to	IEC 61058-1	Switches for appliances. Part 1. General requirements
	Designed according to	UL 498	Standard for Attachment Plugs and Receptacles
	Designed according to	UL 1283	Electromagnetic interference filters
	Designed according to	CSA C22.2 no. 42	General Use Receptacles, Attachment Plugs, and Similar Wiring Devices
	Designed according to	CSA C22.2 no. 8	Electromagnetic interference (EMI) filters





Application standards

Application standards where the product can be used

Organization	Design	Standard	Description
	Designed for applications acc.	IEC/UL 60950	IEC 60950-1 includes the basic requirements for the safety of information technology equipment.
	Designed for applications acc.	IEC 60601-1	Medical electrical equipment - Part 1: General requirements for basic safety and essential performance

Compliances

The product complies with following Guide Lines

Identification	Details	Initiator	Description
	CE declaration of conformity	SCHURTER AG	The CE marking declares that the product complies with the applicable requirements laid down in the harmonisation of Community legislation on its affixing in accordance with EU Regulation 765/2008.
	RoHS	SCHURTER AG	Directive RoHS 2011/65/EU, Amendment (EU) 2015/863
	China RoHS	SCHURTER AG	The law SJ / T 11363-2006 (China RoHS) has been in force since 1 March 2007. It is similar to the EU directive RoHS.
	REACH	SCHURTER AG	On 1 June 2007, Regulation (EC) No 1907/2006 on the Registration, Evaluation, Authorization and Restriction of Chemicals 1 (abbreviated as "REACH") entered into force.
	Medical Technology	SCHURTER AG	Suitable for use in medical equipment according to IEC/UL 60601-1

Dimension [mm]

Line Filter

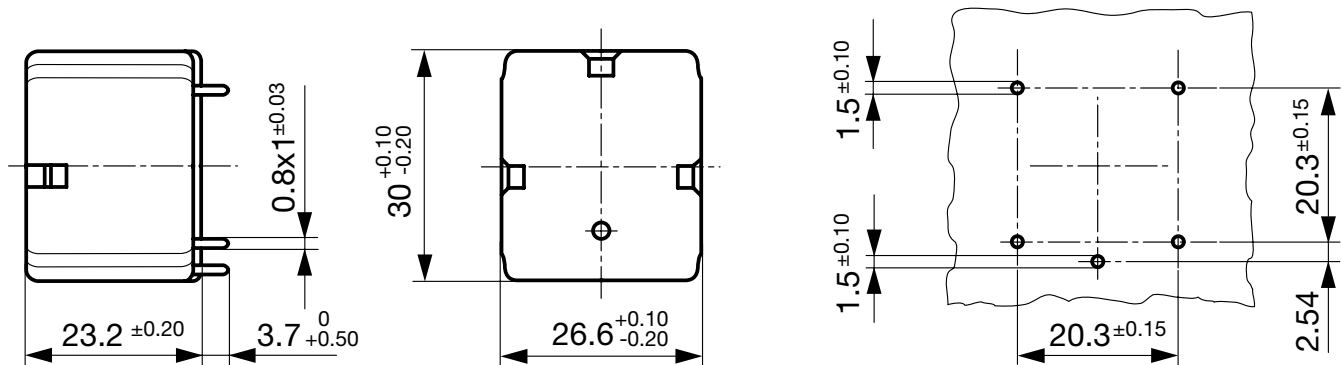

1600 A / 520 V

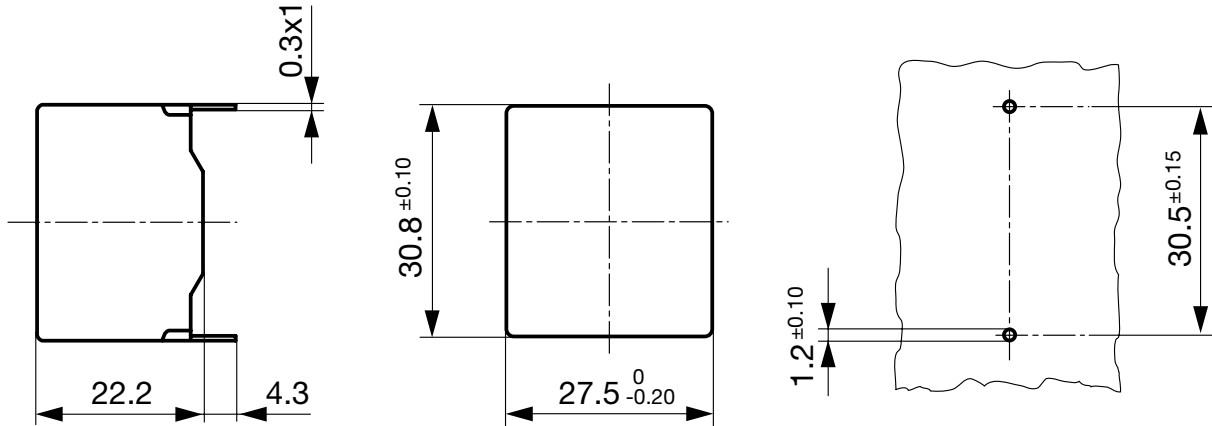

Technical Data of Filter-Components

Rated Current [A]	Filter-Type	Inductances L [mH]	Capacitance CX [nF]	Capacitance CY [nF]	R [MΩ]
1	Standard Version	2 x 11	47	2.2	-
2	Standard Version	2 x 4	47	2.2	-
4	Standard Version	2 x 1.6	47	2.2	-
6	Standard Version	2 x 0.7	47	2.2	-
8	Standard Version	2 x 0.6	47	2.2	-
10	Standard Version	2 x 0.4	47	2.2	-
1	Medical Version (M5)	2 x 11	47	-	1
2	Medical Version (M5)	2 x 4	47	-	1
4	Medical Version (M5)	2 x 1.6	47	-	1
6	Medical Version (M5)	2 x 0.7	47	-	1
8	Medical Version (M5)	2 x 0.6	47	-	1
10	Medical Version (M5)	2 x 0.4	47	-	1

Diagrams

Standard Version

Medical Version (M5)

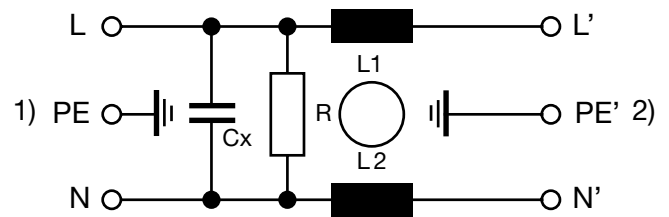
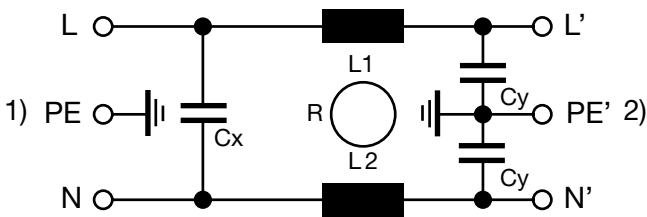

1) Line
 2) Load

1) Line
 2) Load

Attenuation Loss

--- 50Ω differential mode ____ 50Ω common mode

Standard version

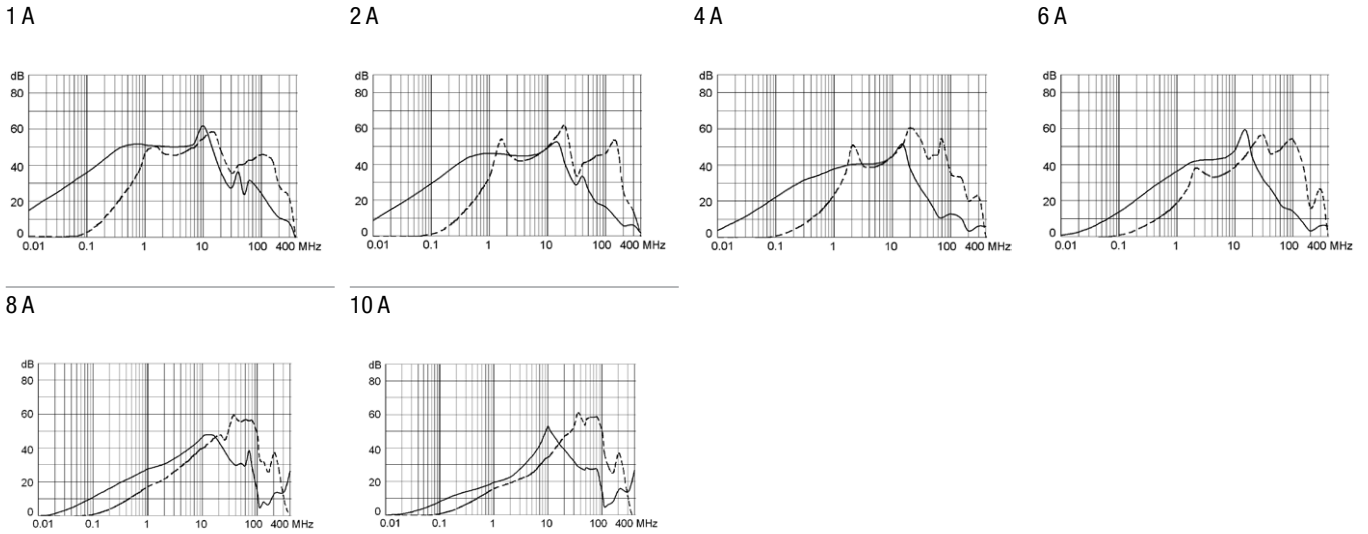

Medical version (M5)

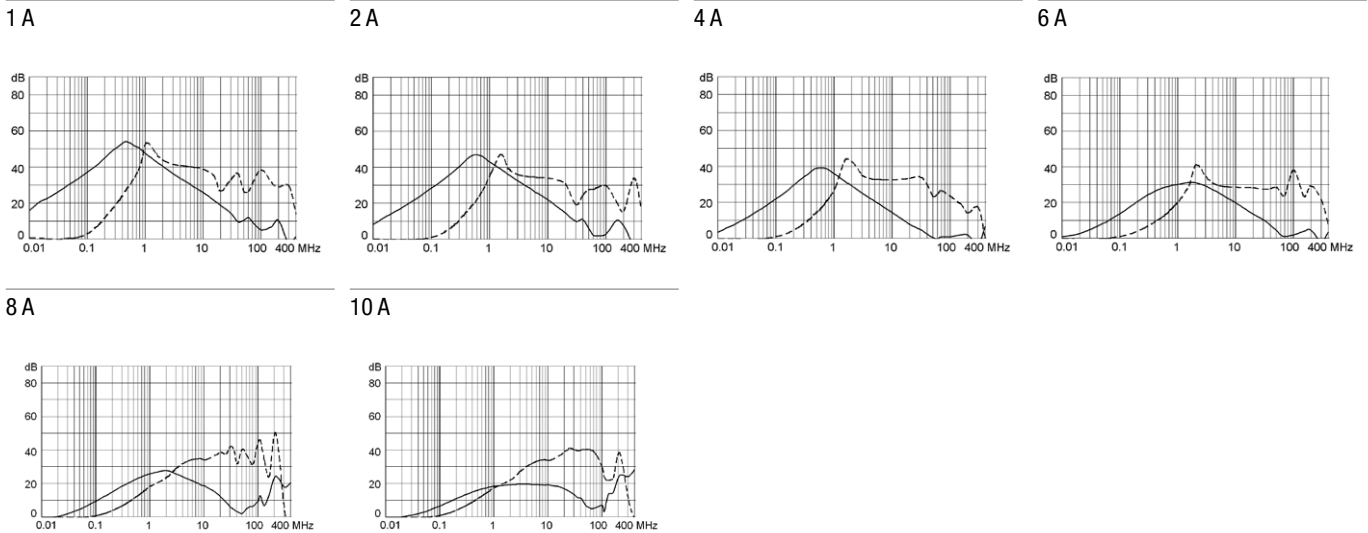

All Variants

Rated Current [A]	Filter-Type	EMC-Shielding	Weight [g]	Order Number
-	-	Shield	20 g	5500.0001
1	Standard Version	Without EMC-shield	35 g	5500.0155.1
2	Standard Version	Without EMC-shield	35 g	5500.0255.1
4	Standard Version	Without EMC-shield	35 g	5500.0455.1
6	Standard Version	Without EMC-shield	35 g	5500.0655.1
8	Standard Version	Without EMC-shield	40 g	5500.0855.1
10	Standard Version	Without EMC-shield	35 g	5500.1055.1
1	Medical Version (M5)	Without EMC-shield	35 g	5500.0155.3
2	Medical Version (M5)	Without EMC-shield	35 g	5500.0255.3
4	Medical Version (M5)	Without EMC-shield	35 g	5500.0455.3
6	Medical Version (M5)	Without EMC-shield	35 g	5500.0655.3
8	Medical Version (M5)	Without EMC-shield	35 g	5500.0855.3
10	Medical Version (M5)	Without EMC-shield	35 g	5500.1055.3

Most Popular.

Availability for all products can be searched real-time: <https://www.schurter.com/en/Stock-Check/Stock-Check-SCHURTER>

Packaging unit 100 Pcs
